



SK-2104

Digital Dialer

Installation Manual

Part Number 151102B, 12/99

Content

Section 1

Introduction 1-1

- 1.1 Features 1-1
- 1.2 Accessory Devices 1-1
- 1.3 About This Manual 1-2
 - 1.3.1 How to Use This Manual 1-2

Section 2

Agency Requirements 2-1

- 2.1 Telephone Requirements 2-1
- 2.2 FCC Warning 2-2
- 2.3 UL Requirements 2-2

Section 3

Installation 3-1

- 3.1 Electrical Specifications 3-1
- 3.2 Wiring Specifications 3-2
- 3.3 Panel Description 3-3
 - 3.3.1 Terminal Description 3-3
 - 3.3.2 LED Descriptions 3-4
 - 3.3.3 5230 Cable Connectors (P1) 3-4
- 3.4 Installation 3-5
 - 3.4.1 Installing the FC-2104 Into the Fire Control Cabinet 3-5
 - 3.4.2 Installing the FC-2104 in the 2190 Accessory Cabinet 3-7
- 3.5 Telephone Line Connections 3-7
- 3.6 Connecting FC-2104 to the Control Panel 3-8
 - 3.6.1 Connecting the FC-2104 to the FC-2884 3-8
 - 3.6.2 Connecting the FC-2104 to the FC-6324 3-9

Section 4

Programming 4-1

- 4.1 Connecting the 5230 for Programming 4-1
- 4.2 5230 Programming 4-2
 - 4.2.1 Default User Codes 4-2
 - 4.2.2 How to Set the Time 4-2
 - 4.2.3 How to Enter and Exit Program Mode 4-2
 - 4.2.4 How to Enter Program Mode 4-2
 - 4.2.5 How to Exit Program Mode 4-2
 - 4.2.6 Step Programming 4-3
 - 4.2.7 Maneuvering in Program Mode 4-3
 - 4.2.8 Programming Steps 4-5

Section 5
Reporting 5-1

5.1 Reporting Formats 5-1
5.2 Reporting Codes 5-2

Section 1

Introduction

The Model SK-2104 is a low-cost Digital Alarm Communicator Transmitter (DACT) that meets the requirements for NFPA 72, UL 864 for Central Station and remote Signaling Service.

1.1 Features

- Multiple reporting formats (SIA, SK 3/1, SESCOA 3/1, Contact ID, SK 4/2, Radionics BFSK).
- Four LEDs indicating, Status (green), DACT Fail (yellow), Line 1 trouble (yellow) and Line 2 trouble (yellow).
- Easy, English-language programming using the 5230 Remote Annunciator.
- Versatile two-number dialing feature for reporting to two different numbers.
- Programmable dialing format (rotary or TouchTone).
- Two phone line monitoring and seizure circuits.
- Transient Voltage protection on phone line inputs.
- Automatic daily test.
- EEPROM memory storage of all programmed information.

1.2 Accessory Devices

- Model 5230 Remote Annunciator (used for programming).
- Model 7860 modular cable with spade lugs for connection to Telco RJ31X plug (optional).
- Model 2190 Accessory Cabinet. Used to house the SK-2104 digital dialer in a separate cabinet.

1.3 About This Manual

This manual is intended for those persons involved with the installation and maintenance of the SK-2104 DACT. It is a comprehensive guide providing detailed instructions, and should be kept for reference. As much as possible, we have tried to organize the manual chronologically by the tasks that need to be performed. Please let us know if the manual does not meet your needs in any way.

1.3.1 How to Use This Manual

In this manual, the following conventions are used:

- Pages of the manual are numbered by section. For example, a page numbered as 5-1 is page 1 of Section 5.
- Text in this type face indicates a 5230 display message: `System Normal.`

Section 2

Agency Requirements

This section list all the requirements for the SK-2104 by agency.

2.1 Telephone Requirements

If requested by telephone company, the following information must be provided before connecting this device to the phone lines:

A.	Manufacturer:	Silent Knight
B.	Model Number:	SK-2104
C.	FCC Registration Number:	AC6USA-33048-AL-E
D.	Type of jack (to be installed by the telephone company):	RJ31X
	Ringer equivalence:	0.9B

This device may not be directly connected to coin-operated telephones or party-line services.

This device cannot be adjusted or repaired in the field. In case of trouble with device, notify the installing company or Silent Knight for an RMA number and then return it to:

Silent Knight

7550 Meridian Circle

Maple Grove, MN 55369-4927

800-328-0103 or 612-493-6455

If the Model SK-2104 causes harm to the telephone network, the telephone company will notify the user in advance that temporary discontinuance of service may be required. If advanced notice is not practical, the telephone company will notify the customer as soon as possible. You as the user have the right to file a complaint with the Federal Communications Commission if you believe it is necessary.

The telephone company may make changes in its facilities, equipment, operations, or procedures that could affect the operation of the equipment. If this happens, the telephone company will provide advance notice to allow you to make the necessary modifications to maintain uninterrupted service.

2.2 FCC Warning

Warning

This device has been verified to comply with FCC Rules Part 15. Operation is subject to the following conditions:
(1) This device may not cause radio interference, and (2) This device must accept any interference received, including interference that may cause undesired operation.

2.3 UL Requirements

The SK-2104 is UL listed as a Control Unit for use in Central Station Fire-Protective Signalling Systems and Remote Signaling Systems (UL864, NFPA 72). Install in accordance to NFPA requirements.

Section 3

Installation

This section contains information necessary to install the SK-2104 Fire Communicator and accessories.

3.1 Electrical Specifications

Loop Resistance:	Data	25Ω
	-	25Ω
	+	25Ω
Max. Current:	Alarm:	70 mA (while dialing)
	Standby:	33 mA
Operating Voltage:		24 VDC
Phone Line Monitor Voltage:		2.75 VDC min.

3.2 Environmental Specifications

It is important to protect the SK-2104 panel from water. To prevent water damage, the following conditions should be AVOIDED when mounting the unit:

Note: The following statements apply to the SK-2104 when mounted in the 2190 Accessory Cabinet.

- Do not mount directly on exterior walls, especially masonry walls (condensation).
- Do not mount directly on exterior walls below grade (condensation).
- Protect from plumbing leaks.
- Protect from splash caused by sprinkler system inspection ports.
- Do not mount in areas with humidity-generating equipment (such as dryers, production machinery, etc.).
- Operating temperature range is 32° to 120° F (0° to 49° C).
- Indoor use only.
- 10% to 85% non-condensing humidity at 30°C (86°F).
- Non-corrosive environment.

3.3 Wiring Specifications

Induced noise (transfer of electrical energy from one wire to another) can interfere with telephone communication or even cause false alarms. To avoid induced noise, follow these guidelines when mounting the SK-2104 in the 2190 Accessory Cabinet:

- Isolate input wiring from high current output and power wiring. Do not pull one multi-conductor cable for the entire panel. Instead, separate the wiring as follows:

High Voltage	AC Power
Audio input/output	Phone Line Circuits, Terminal Block 1, Terminals 1-8
Data Communication Circuits	Terminal Block 2, Terminals 1-3

Important! Do not run 120 VAC line voltage in fire alarm raceways.

- Do not pull wires from different groups through the same conduit. If you must run them together, do so for as short a distance as possible or use shielded cable. Connect the shield to earth ground at the panel only.
- High frequency noise, such as that produced by the inductive reactance of a speaker or bell, can also be reduced by running the wire through ferrite shield beads or by wrapping it around a ferrite toroid.
- Route the wiring around the inside perimeter of the cabinet. It should not cross the circuit board where it could induce noise into the sensitive microelectronics and/or pick up unwanted RF noise from the high speed circuits. See Figure 3-1 for an example.

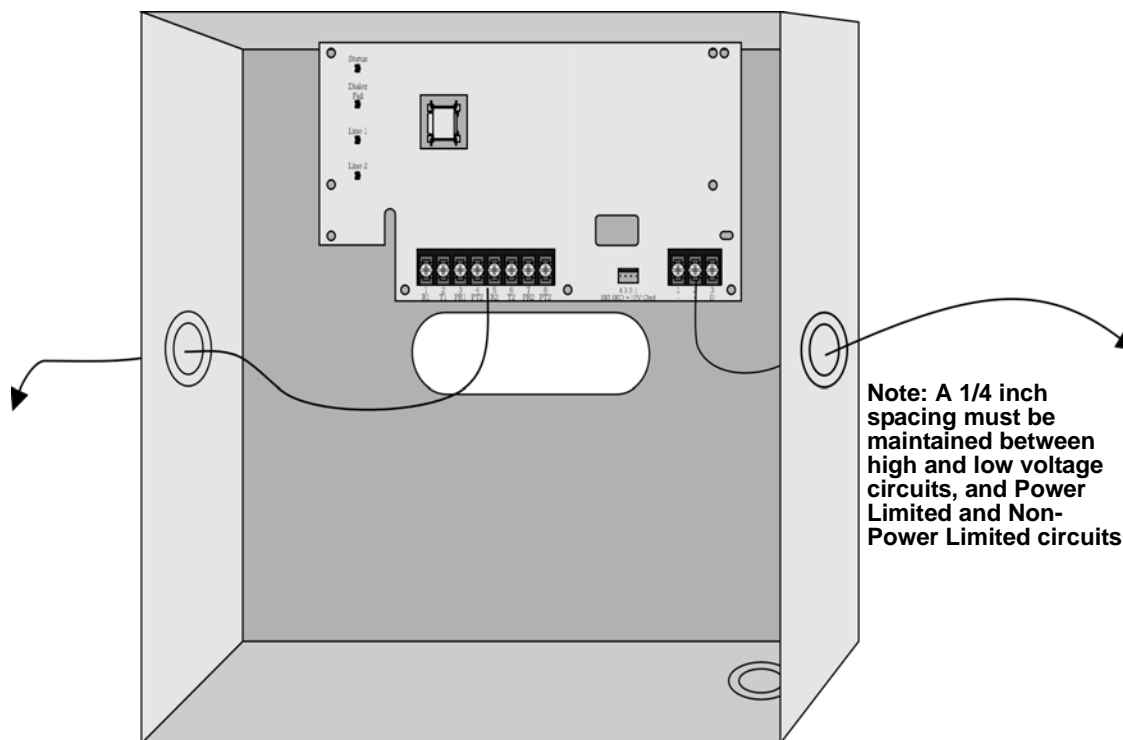

Figure 3-1 Wire Routing Example

3.4 Panel Description

This section describes the SK-2104 board components, including terminal strips, LEDs, and cable connectors. See Figure 3-2.

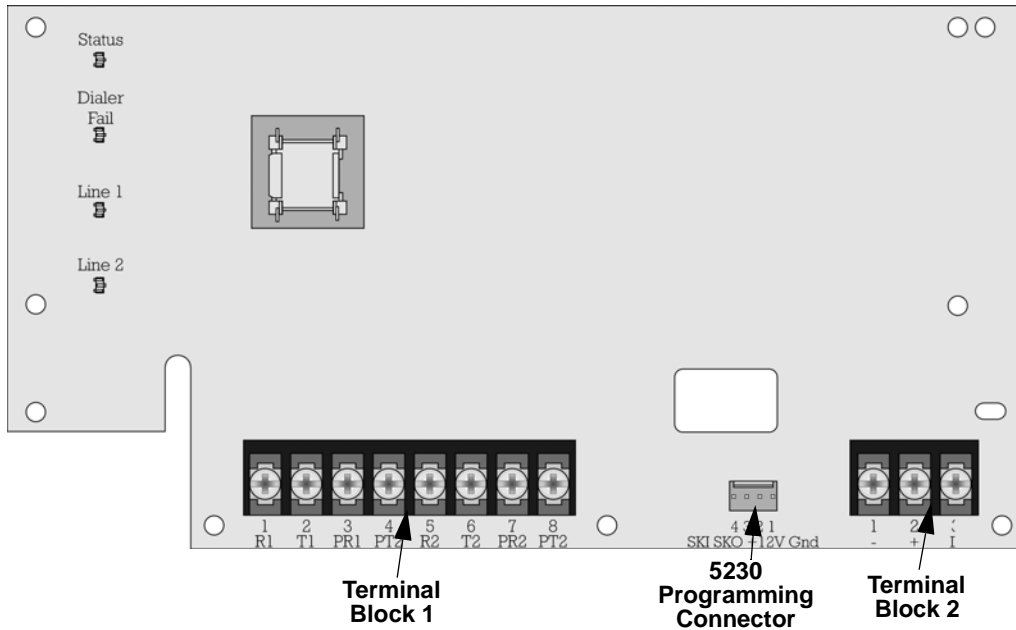

Figure 3-2 The SK-2104 Circuit Board

3.4.1 Terminal Description

Table 3-1 lists the terminals by number and describes each terminal's use.

Table 3-1: Terminal Description by Terminal Block

Terminal Block #	Terminal #	Description	Comments
1	1	Telco Ring	Phone Line 1
	2	Telco Tip	
	3	House Ring	
	4	House Tip	
	5	Telco Ring	Phone Line 2
	6	Telco Tip	
	7	House Ring	
	8	House Tip	
2	1	- (Ground)	Serial Data Power Limited
	2	+ (+24 VDC)	
	3	D (Data)	

3.4.2 LED Descriptions

Table 3-2 describes what each of the four LED indicate on the SK-2104 dialer.

Table 3-2: LED Descriptions

LED	State	Description
Status	On Steady	Communicating with central station receiver.
	Off	Power loss.
	Quick Flash	On -Off flashing that indicates a serial communication problem between the SK-2104 and the control panel.
	Slow Flash	The LED flashes briefly every 4 seconds indicating that the system is normal.
Dialer Fail	On	Indicates that there was a communication problem.
	Off	DACT has no errors.
Line 1	On	Phone line fault exists. A fault condition means that the phone line voltage is less than 1.8 VDC and the loop current is less than 5 mA.
	Off	Phone line is O.K.
	Flashing	Indicates that the DACT had an error while communicating. Possibly no handshake or kiss-off tone.
Line 2	On	Phone line fault exists. A fault condition means that the phone line voltage is less than 1.8 VDC and the loop current is less than 5 mA.
	Off	Phone line is O.K.
	Flashing	Indicates that the DACT had an error while communicating. Possibly no handshake or kiss-off tone.

3.4.3 5230 Cable Connectors (P1)

The connector on the SK-2104 (see Figure 3-2 for connector location) is used for the following:

Connector	Function
5230 Programming Connector	Used as a quick-connect for the 5230 Remote Annunciator to do programming.

For instruction on how to connect the 5230 to the control panel refer to Section 4.1.

3.5 Installation Options

3.5.1 Installing the SK-2104 Into the Fire Control Cabinet

The DACT can be mounted inside the SK-2224, SK-4224 or SK-6324 cabinet, underneath the control panel printed-circuit board (PC board). The cabinet for the SK-2224, SK-4224, and SK-6324 are the same, therefore the mounting procedure is identical for these control panels.

Follow these steps to install the SK-2104 into the control panel cabinet:

Note: Figure 3-3 and Figure 3-4 show the SK-4224 control panel.

Caution!

Many of the circuit board components are extremely sensitive to static electricity. The following procedures reduce the possibility of damaging components with static electricity:

1. Before handling the circuit board in any way, discharge your body's static electric charge by touching a grounded surface. Wear a grounding wrist strap if one is available.
2. Do not remove parts from their antistatic containers or bags until you are ready to install them. When removing a circuit board from a cabinet, immediately place it in an antistatic bag or container.
3. When handling a circuit board, hold it by its edges, and avoid touching the circuitry.
4. Do not slide circuit boards over any surface.
5. Avoid having plastic, vinyl, and foam in your work area.
6. Limiting your movement during installation and or removal reduces static electricity.

1. Unplug the AC transformer connector from the control panel. See Figure 3-3.

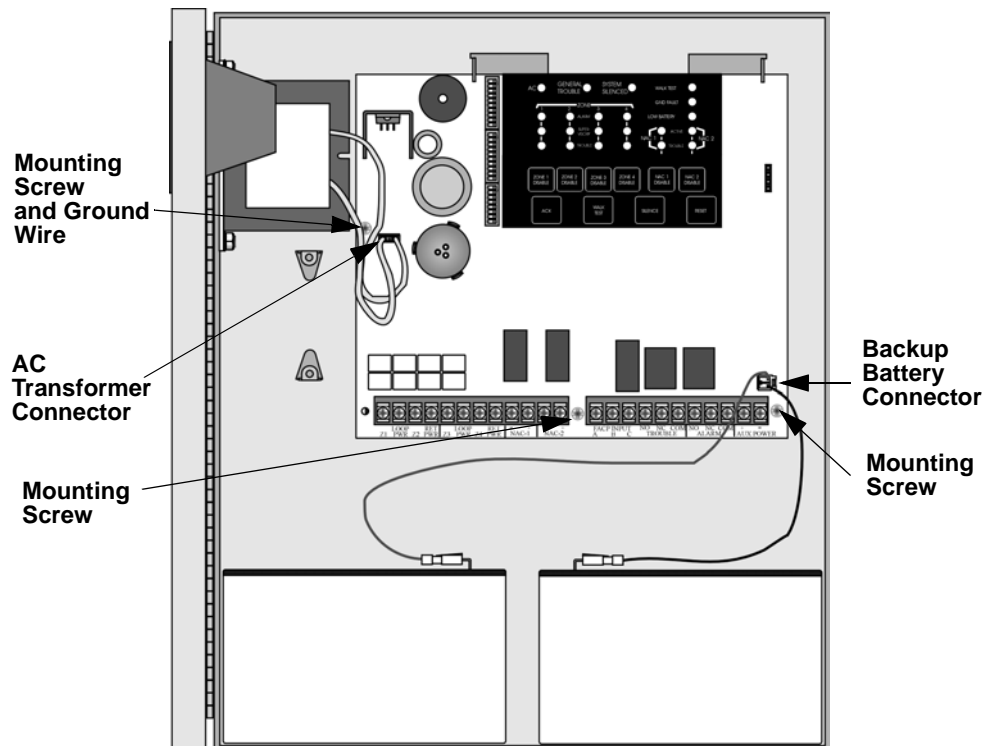

Figure 3-3 Control Panel Connectors and Mounting Screw Locations

2. Disconnect the ground wire. See Figure 3-3.
3. Disconnect the backup battery connector. See Figure 3-3.
4. Unscrew the three control panel PC board mounting screws. See Figure 3-3.
5. Remove the control panel PC board and place it on a non conductive, static free surface.
6. Insert the three plastic stand-offs into the appropriate circuit board holes. See Figure 3-4.
7. Insert the SK-2104 PC board as shown in Figure 3-4.
8. Mount the SK-2104 with four self-tapping screws (provided).

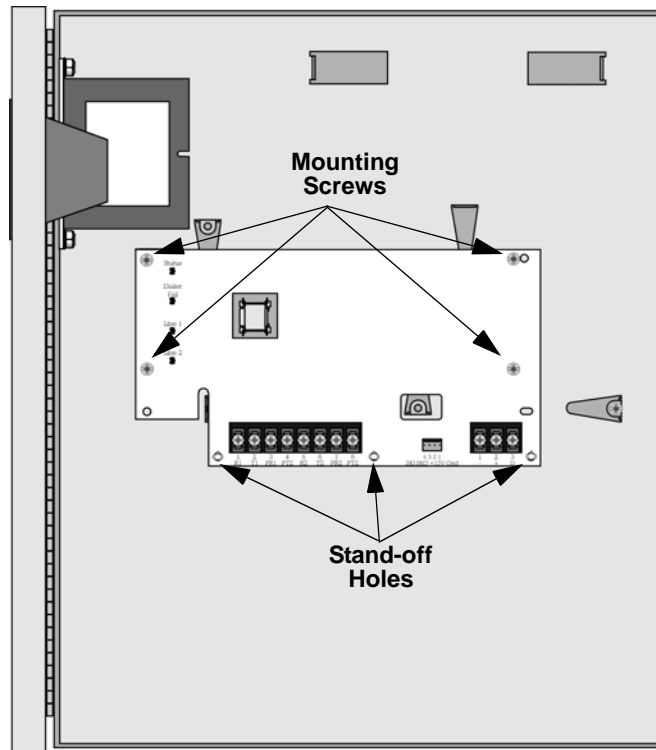

Figure 3-4 Placement of SK-2104 in Cabinet

9. Reinsert the fire control panel PC board. See Figure 3-3
10. Reconnect the AC transformer connector. See Figure 3-3.
11. Reconnect the ground wire. See Figure 3-3.
12. Reconnect the backup battery. See Figure 3-3.

3.5.2 Installing the SK-2104 in the SK-2190 Accessory Cabinet

Read the environmental specifications in Section 3.1 before mounting the 2190 Accessory Cabinet. This will ensure that you select a suitable location.

The panel should be accessible to main drop wiring runs. It should be mounted as close to the center of the building as possible and located within a secured area, but should be accessible for testing and service.

Mount the SK-2104 so it is firmly secured to the wall surface. When mounting on concrete, especially when moisture is expected, attach a piece of 3/4 inch plywood to the concrete surface and then mount the SK-2104 to the plywood. Also mount any other modules to the plywood.

3.6 Telephone Line Connections

The SK-2104 control panel connects to the phone lines with a 7860 cable, which plugs into an RJ31X phone jack. The telephone company will install an RJ31X phone jack if you request them. Both telephone lines must be installed to comply with NFPA 72. Wire the phone lines as shown in Figure 3-5.

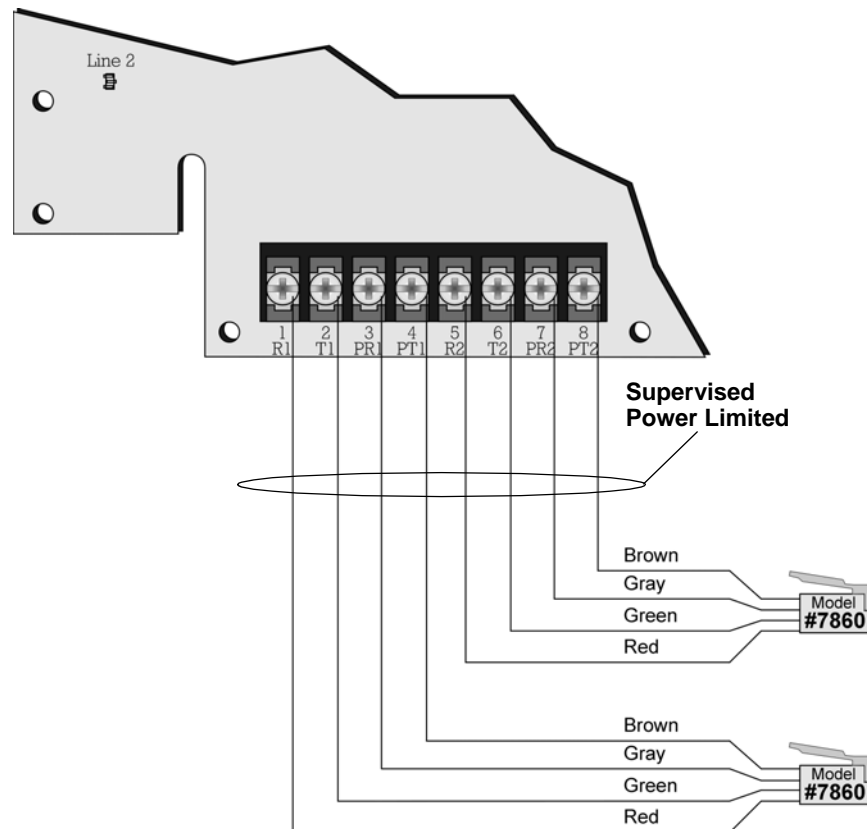

Figure 3-5 Telephone Line Connections

3.7 Connecting SK-2104 to the Control Panel

This section describes how to connect the SK-2104 DACT to the compatible control panels.

3.7.1 Connecting the SK-2104 to the SK-2884

The SK-2224/4224 control panel communicates to the SK-2104 via a serial data bus. The SK-2884 Serial Board provides an interface for the SK-2104 to communicate to the control panel. Figure 3-6 illustrates how the SK-2104 connects to the SK-2884 serial board.

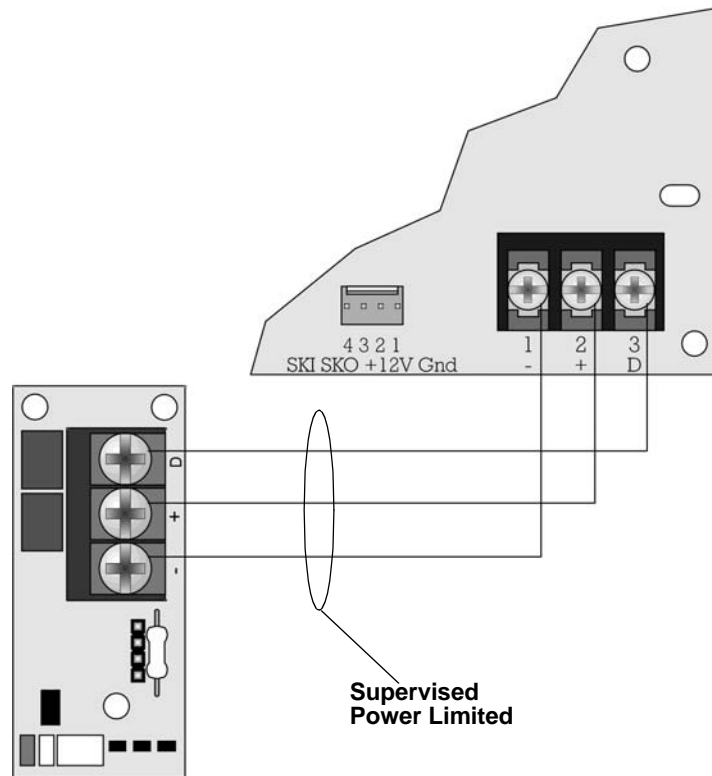

Figure 3-6 Serial Data Connections from the SK-2104 to the SK-2884

3.7.2 Connecting the SK-2104 to the SK-6324

The SK-6324 control panel has the serial communication port built onto the control panel so no additional circuit board is required. Figure 3-7 illustrates how to connect the SK-2104 to the SK-6324 control panel.

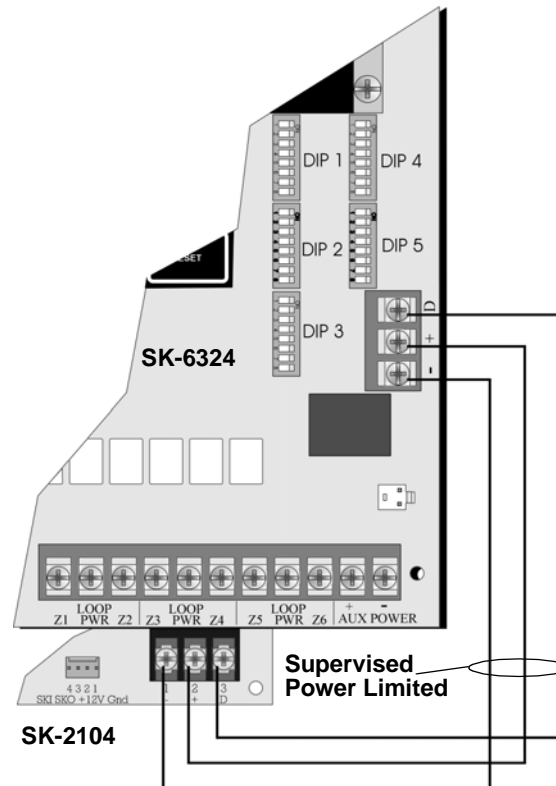

Figure 3-7 Serial Data Connections From the SK-2104 to the SK-6324

Section 4

Programming

This section contains information pertaining to the programming of the SK-2104 with the 5230 Remote Annunciator. All programming is stored in an EEPROM (Electrically Erasable Read-Only Memory) chip, which is non-volatile memory storage. The various areas of programming are referred to as programming steps. These steps are covered in greater detail in Section 4.2.6.

4.1 Connecting the 5230 for Programming

Connect the 5230 to the SK-2104 using a P/N 130294 Quick Connect Cable as shown in Figure 4-1

Important!

The 5230 is used for programming only and must be removed when programming is completed. The 5230 can not be used as a remote annunciator for the SK-2104.

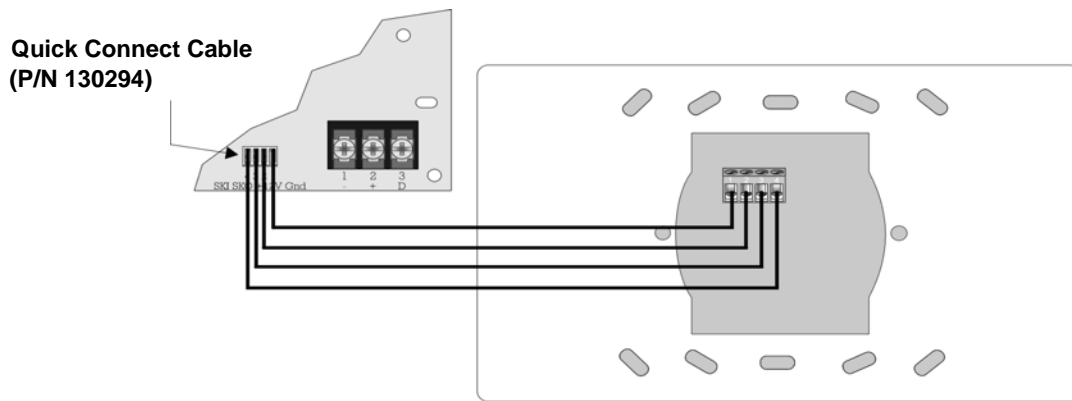

Figure 4-1 5230 Connections to the SK-2104.

4.2 5230 Programming

4.2.1 Default User Codes



The 5230 uses two programmable user codes (Installer and Operator codes). This section will refer to these user codes as either the Installer Code or the Operator Code. Table 4-1 lists the factory default Installer and Operator codes:

Table 4-1: Factory Default User Codes

User Codes	Factory Default
Installer Code	2104
Operator Code	1111

4.2.2 How to Set the Time

To set the time in the SK-2104, follow these steps:



1. Press .
2. Press .
3. Enter the Installer code.
4. Enter the current time in military (24 hour clock) time.

4.2.3 How to Enter and Exit Program Mode

This section describes how to enter and exit programming mode.

4.2.4 How to Enter Program Mode

Follow these steps to enter program mode:

1. Press .
2. Press .
3. Enter the Installer Code.

4.2.5 How to Exit Program Mode

To exit program mode press    

4.2.6 Step Programming

All programming, for the SK-2104, done through the 5230 is done in steps. Each step programs a set parameter of the SK-2104, such as phone numbers, reporting formats, and zone functions.

4.2.7 Maneuvering in Program Mode

This section describes how to maneuver through programming more efficiently.

4.2.7.1 Entering Selected Values

When in program mode the two-line display shows the step name on the first line and the shows the present value programmed for that step (see Figure 4-2).

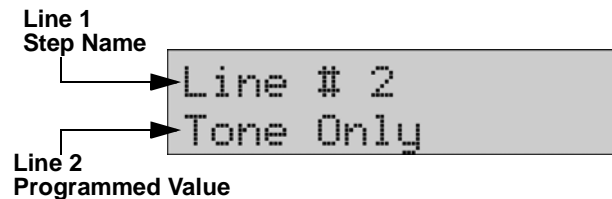

Figure 4-2 Example of 5230 Display

To enter a new value into line 2, simply enter that value and press the enter key.

Yes or No Selections

When the selection choices are Yes or No, you can press any numbered key to toggle the selection between Yes or No then press the enter key to program your choice into memory.

Selecting Alpha-numeric characters









To enter a number 0-9, simply press the key corresponding to the digit(s) you desire. For example, to enter a phone number of 123-4567 press the keys, in order, 1234567 then enter.

To enter Alpha character (A-E) press the **DISABLE SHIFT** followed by digits 1 (for A), 2 (for B), 3 (for C), 4 (for D), 5 (for E). For example, to enter a 3/1 Alarm Code of D (see Table 4-3 for step information), press **DISABLE SHIFT** **LOAD 4** **ENTER** to enter the D character.

Special Character and Functions

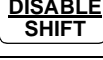
Some phone number require special characters or functions to dial the central station correctly. Table 4-2 lists the special character used for dialing a phone number and CIC (Carrier ID Code) codes.

Table 4-2: Special Characters for Dialing Sequence



Character or Function	Touchpad Inputs	Displayed Character
Pause	 	A
*	 	B
#	 	C
Look for second dial tone.	 	D

4.2.7.2 Bypass a Step

To bypass a step to get to the next step, simply press the  key without entering any data.

4.2.7.3 Go to a Step

You may desire to program only a few features and do not wish to step through the entire programming menu. To do this follow the steps below.

1. Press .
2. Enter the step number you wish to go to.
3. Press .

4.2.8 Programming Steps

Table 4-3 lists all the steps names, their task, the choices available in those steps, and the factory default setting of those steps.

Table 4-3: List of Programming Steps

Step #	Task	Choices	Default	
Step 0	3/1 Alarm Code	0 - 9, A, B, C, D, E	1	Sets the 3/1 reporting format code sent for a "Fire Alarm". Use the Shift key plus digits 1 - 5 for letters A - E.
Step 1	3/1 Sprnkr Code	0 - 9, A, B, C, D, E	2	Sets the 3/1 reporting format code sent for a "Sprinkler Supervisory". Use the Shift key plus digits 1 - 5 for letters A - E.
Step 2	3/1 Trouble Code	0 - 9, A, B, C, D, E	8	Sets the 3/1 reporting format code sent for a "Trouble". Use the Shift key plus digits 1 - 5 for letters A - E.
Step 3	3/1 Restore Code	0 - 9, A, B, C, D, E	7	Sets the 3/1 reporting format code sent for a "Restore". Use the Shift key plus digits 1 - 5 for letters A - E.
Step 4	3/1 Test Code	0 - 9, A, B, C, D, E	9	Sets the 3/1 reporting format code sent for a "Test Code". Use the Shift key plus digits 1 - 5 for letters A - E.
Step 5	Line #1	1 = Tone Only 2 = Rotary or Tone 3 = Rotary Only	1	If option 1 is selected the DACT will use TouchTone format only. If option 2 is chosen the DACT will first attempt to use TouchTone format and if it fails to communicate it will switch to rotary format as a backup.
Step 6	Line #2	1 = Tone Only 2 = Rotary or Tone 3 = Rotary Only	1	If option 1 is selected the DACT will use TouchTone format only. If option 2 is chosen the DACT will first attempt to use TouchTone format and if it fails to communicate it will switch to rotary format as a backup.
Step 7	Report Alarm 1	1 = Yes 2 = Must 3 = No	Yes	Specify phone line priority for this type of call. Must = Alarms must report on this line. Yes = Alarms will attempt to report on this line first, and backup to other line if it fails to communicate. No = Alarms will not report to this line.
Step 8	Report Trouble 1	1 = Yes 2 = Must 3 = No	Yes	Specify phone line priority for this type of call. Must = Alarms must report on this line. Yes = Alarms will attempt to report on this line first, and backup to other line if it fails to communicate. No = Alarms will not report to this line.
Step 9	Report Disable 1	1 = Yes 2 = Must 3 = No	Yes	Specify phone line priority for this type of call. Must = Alarms must report on this line. Yes = Alarms will attempt to report on this line first, and backup to other line if it fails to communicate. No = Alarms will not report to this line.

Table 4-3: List of Programming Steps

Step #	Task	Choices	Default	
Step 10	Report Test 1	1 = Yes 2 = Must 3 = No	Yes	Specify phone line priority for this type of call. Must = Alarms must report on this line. Yes = Alarms will attempt to report on this line first, and backup to other line if it fails to communicate. No = Alarms will not report to this line.
Step 11	Account #1	6-digits	102104	Enter six-digits for an account number. For accounts shorter than 6-digits use leading zeros before you enter account number, so that all six places are filled. For example, if the format (like 3/1) requires a shorter account number, such as 123 enter 000123.
Step 12	Attempts #1	1 - 5	3	Select the number of attempts the DACT will make to report to this account before a DACT failed condition occurs. The dialer will then call the other account. A total of 15 attempts will be made.
Step 13	Format #1	0 = SIA8 1 = Reserved 2 = SK4/2 3 = BFSK14 4 = BFSK23 5 = SIA20 6 = 3/1 14 7 = 3/1 23 8 = Contact ID	SK4/2	Selects the reporting format to be used on phone number 1. Enter the number of the choice (see choice column) to select the desired reporting format. See Section 7 for detailed information on the SK-2104 reporting formats.
Step 14	CIC #1	1 to 8 digits	None	Carrier Identification Code is the prefix that needs to be dialed before a phone number to access a particular long distance carrier. Use special characters to add pauses, #, *, and "look for second dial tone" characters into the phone number. See Table 4-2 for special characters.
Step 15	Phone #1	1 to 16 digits	None	Enter 16 digits for phone number 1. Use special characters to add pauses, #, *, and "look for second dial tone" characters into the phone number. See Table 4-2 for special characters.
Step 16	Report Alarm 2	1 = Yes 2 = Must 3 = No	Yes	Specify phone line priority for this type of call. Must = Alarms must report on this line. Yes = Alarms will attempt to report on this line first, and backup to other line if it fails to communicate. No = Alarms will not report to this line.
Step 17	Report Trouble 2	1 = Yes 2 = Must 3 = No	Yes	Specify phone line priority for this type of call. Must = Alarms must report on this line. Yes = Alarms will attempt to report on this line first, and backup to other line if it fails to communicate. No = Alarms will not report to this line.

Table 4-3: List of Programming Steps

Step #	Task	Choices	Default	
Step 18	Report Disable 2	1 = Yes 2 = Must 3 = No	Yes	Specify phone line priority for this type of call. Must = Alarms must report on this line. Yes = Alarms will attempt to report on this line first, and backup to other line if it fails to communicate. No = Alarms will not report to this line.
Step 19	Report Test 2	1 = Yes 2 = Must 3 = No	Yes	Specify phone line priority for this type of call. Must = Alarms must report on this line. Yes = Alarms will attempt to report on this line first, and backup to other line if it fails to communicate. No = Alarms will not report to this line.
Step 20	Account #2	6-digits	202104	Enter up to six-digits for an account number. For accounts shorter than 6-digits use leading zeros before you enter account number, so that all six places are filled. For example, if the format (like 3/1) requires a shorter account number, such as 123 enter 000123.
Step 21	Attempts #2	3 - 5	3	Select the number of attempts the DACT will make to report to this account before a DACT failed condition occurs. The DACT will then call the other account. A total of 15 attempts will be made.
Step 22	Format #2	See Step 13.	SK4/2	See Step 13.
Step 23	CIC #2	1 to 8 digits	None	See Step 14.
Step 24	Phone #2	1 to 16 digits	None	See Step 15.
Step 25	Computer Account	6-digits	302104	Account number used when reporting to the downloading computer. If account number is shorter than 6-digits use leading zeros.
Step 26	Computer CIC	1 to 8-digits	None	Carrier Identification Code is the prefix that needs to be dialed before a phone number to access a particular long distance carrier. Use special characters to add pauses, #, *, and "look for second dial tone" characters into the phone number. See Table 4-2 for special characters.
Step 27	Computer Phone	1 to 16-digits	None	Enter up to 16 digits for phone number 1. Use special characters to add pauses, #, *, and "look for second dial tone" characters into the phone number. See Table 4-2 for special characters.
Step 28	# Rings	0 - 15	0	Used to set the number of rings before the SK-2104 will answer the phone line to perform a download from a computer. 0 = disabled, which means the SK-2104 will not answer an in coming call.
Step 29	Installers Code	4-digits	2104	Enter a 4-digit code to be used by the installer or service technician. The installer code allows the user to initiate downloads, set time, and entering program mode.

Table 4-3: List of Programming Steps

Step #	Task	Choices	Default	
Step 30	Operators Code	4-digits	1111	Enter a 4-digit code to be used by the operator. The operator code allows the user to silence annunciations and to conduct manual tests.
Step 31	Test Time	24-hrs military time	01:30	Enter the time that a automatic test will be sent to central station. Use a 24-hour military time format. For example, to enter the time 5:15 pm enter 17:15. Use leading zeros for single-digit hours, such as 01:30 etc. Note: Any events that have not been restored will be sent along with the test report.
Step 32	Test Interval	0 to 31	1	Enter how often (in days 1 to 30) the control panel will do an automatic phone test.
Step 33	Low AC Hours	0 to 15	0	Set the number of hours the control panel will wait to report a loss of AC power to the central station. To comply with Central Station Fire-Protective Signaling Systems the delay must be set from 6 to 12 hours. To comply with Remote Signaling Systems the delay must be set to 15 hours. Note: The delay feature in the compatible control panels must be set to 0. Refer to the control panel installation manual to set this feature to 0.

Section 5

Reporting

The SK-2104 can transmit information in 5 different formats. This section describes the five basic reporting formats of the SK-2104 and the codes that they send to a central station receiver. Of these 5 formats some of the formats offer a more specific selection for that format. For example, you can select a 3/1 format that requires a 1400 or 2300 Hz handshake, or SIA format that can handle 8 of 20 events per call. Selecting the correct format depends on the type of receiver that will receive calls from the SK-2104.

The SK-2104 DACT is compatible with the Silent Knight 9800 and 9500 Central Station receivers.

5.1 Reporting Formats

This section gives a description of each of the SK-2104 reporting formats. Refer to Table 5-1.

Table 5-1: Reporting Formats Descriptions

Format Name		Description
Category Name	Programming Name	
3/1	3/1 14	Old format, transmits a 3-digit account number and a 1-digit alarm code. Transmissions are acknowledged at 1400 Hz.
	3/1 23	Old format, transmits a 3-digit account number and a 1-digit alarm code. Transmissions are acknowledged at 2300 Hz.
4/2	SK 4/2	Tone burst format, transmits a 4-digit account code and 2-digit alarm code. Transmissions are acknowledged at 1400 Hz.
BFSK	BFSK14	Radionics format which transmits a high-speed, single-round, 3-digit account number, followed by report information. Transmissions are acknowledged at 1400 Hz.
	BFSK23	Radionics format which transmits a high-speed, single-round, 3-digit account number, followed by report information. Transmissions are acknowledged at 2300 Hz.
SIA	SIA8	Security Industry Association standard communication format which send a maximum of 8 events per call.
	SIA20	Security Industry Association standard communication format which send a maximum of 20 events per call. Up to a 6-digit account number.
Contact ID	Contact ID	Ademco Contact ID format. DTMF (Dual Tone Multiple Frequency) format. Send a 4-digit account number. Transmission are acknowledged at both 1400 and 2300 Hz.

5.2 Reporting Codes

Table 5-2 list the events sent by the SK-2104 and the code that is sent for that event by the type of reporting format used.

Table 5-2: Event and Reporting Code by Format

Event	SIA8 & 20	SK4/2	3/1 1400 &2300	BFSK14 & 23	Contact ID
Fire Alarm 1-4	FA1 - FA4	01 - 04	Alarm Code	01 - 04	1 110 001 - 1 110 004
Fire Alarm Restore 1-4	FH1 - FH4	21 - 24	Restore Code	E1 - E4	3 110 001 - 3 110 004
Fire Trouble 1-4	FT1 - FT4	61 - 64	Trouble Code	F1 - F4	1 373 001 - 1 373 004
Fire Trouble Restore 1-4	FJ1 - FJ4	71 - 74	Restore Code	E1 - E4	3 373 001 - 3 373 004
Sprinkler Supervisory 1-4	SS1 - SS4	01 -04	Sprinkler Code	01 - 04	1 203 001 - 1 203 004
Sprinkler Supervisory Restore 1-4	SR1 - SR4	21 - 24	Restore Code	E1 - E4	3 203 001 - 3 203 004
Sprinkler Trouble 1-4	ST1 - ST4	61 - 64	Trouble Code	F1 - F4	1 203 001 - 1 203 004
Sprinkler Trouble Restore 1-4	SJ1 - SJ4	71 - 74	Restore Code	E1 - E4	3 203 001 - 3 203 004
Serial Bus Trouble	ET0	33	Trouble Code	FD	1 330 000
Serial Bus Restore	ERO	37	Restore Code	ED	3 330 000
Annunciator Trouble	ET1	33	Trouble Code	FD	1 330 001
Annunciator Restore	ER1	37	Restore Code	ED	3 330 001
Bell Trouble	ET32	33	Trouble Code	FD	1 320 001
Bell Restore	ER32	37	Restore Code	ED	3 320 001
Earth Ground Trouble	ET38	33	Trouble Code	FD	1 310 000
Earth Ground Restore	ER38	37	Restore Code	ED	3 310 000
AC Trouble	AT0	60	Trouble Code	FA	1 301 000
AC Restore	AR0	70	Restore Code	EA	3 301 000
Battery Trouble	YT0	69	Trouble Code	F9	1 302 000
Battery Restore	YR0	79	Restore Code	E9	3 302 000
Trouble Phone Line #1	LT1	31	Trouble Code	FB	1 351 000
Restore Phone Line #1	LR1	35	Restore Code	EB	3 351 000
Trouble Phone Line #2	LT2	32	Trouble Code	FC	1 352 000
Restore Phone Line #2	LR2	36	Restore Code	EC	3 352 000
Communications Failure Line #1	YC1	31	Trouble Code	FB	1 351 000
Communications Restore Line #1	YK1	35	Restore Code	EB	3 351 000
Communications Failure Line #2	YC2	32	Trouble Code	FC	1 352 000
Communications Restore Line #2	YK2	36	Restore Code	EC	3 352 000
Manual Test	RX0	30	Test Code	EE	1 601 000
Automatic Test	RP0	30	Test Code	EE	1 602 000
Downloading Passed	RS0	30	Test Code	EF	1 412 000
Downloading Failed	RU0	30	Test Code	FF	1 413 000
Data Lost	RT0	39	Trouble Code	FE	1 354 000

Silent Knight Fire Product Warranty and Return Policy

General Terms and Conditions

- All new fire products manufactured by Silent Knight have a limited warranty period of 18 months from the date of manufacture against defects in materials and workmanship. See limited warranty statement for details.
- This limited warranty does not apply to those products that are damaged due to misuse, abuse, negligence, exposure to adverse environmental conditions, or have been modified in any manner whatsoever.

Repair and RA Procedure

- All products that are returned to Silent Knight for credit or repair require a RA (Return Authorization) number. Call Silent Knight Customer Service at 800-446-6444 or 763-493-6435 between 8:00 A.M. and 4:45 P.M. CST, Monday through Friday to obtain a return authorization number. Silent Knight Technical Support is available at 800-328-0103 between 8:00 A.M. and 6:00 P.M. CST, Monday through Friday.
- RA number must be prominently displayed on the outside of the shipping box. See return address example under Advanced Replacement Policy.
- Include a packing slip that has the RA number, a content list, and a detailed description of the problem should be included with each return.
- All products returned to Silent Knight must be sent freight pre-paid. After product is processed, Silent Knight will pay for shipping product back to customer via UPS ground.
- Return the Silent Knight product circuit board only. Products that are returned in cabinets will be charged an additional \$50 to cover the extra shipping and handling costs over board only returns. **Do not return batteries.** Silent Knight has the authority to determine if a product is repairable. Products that are deemed un-repairable will be returned to the customer.
- Product that is returned that has a board date code more than 18 months from date of manufacture will be repaired and the customer will be assessed the standard Silent Knight repair charge for that model.

Advanced Replacement Policy

- Silent Knight offers an option of advance replacement for fire product printed circuit boards that fail during the first 6 months of the warranty period.
- For advance replacement of a defective board contact your local Silent Knight Distributor or call Silent Knight at 800-446-6444 or 763-493-6435 to obtain a RA (Return Authorization) number and request advanced replacement.
- Customers without a Silent Knight account must use a MasterCard, Visa, or American Express credit card to get an advance replacement.

- A new or refurbished board will be shipped to the customer. The customer will initially be billed for the replacement board but a credit will be issued after the repairable board is received at Silent Knight. All returned products must comply with the guidelines described under “General Terms and Conditions”.
- The defective board must be returned within 30 days of shipment of replacement board for customer to receive credit. No credit will be issued if the returned board was damaged due to misuse or abuse.
- Repairs and returns should be sent to:

Silent Knight

Attn: Repair Department

7550 Meridian Circle Suite 100

Maple Grove, MN 55369-4927

RA Number: _____

Limited Warranty

Silent Knight warrants that the products of its manufacture shall be free from defects in materials or workmanship for 18 months from the manufacturing date code on the printed circuit board, if such goods have been properly installed, are subject to normal proper use, and have not been modified in any manner whatsoever. Upon return of the defective product, Silent Knight will at its sole discretion, either repair or replace, at no cost, such goods as may be of defective material or workmanship. Customers outside the United States are to return products to their distributor for repair.

SILENT KNIGHT SHALL NOT UNDER ANY CIRCUMSTANCES BE LIABLE FOR ANY INCIDENTAL OR CONSEQUENTIAL DAMAGES ARISING FROM LOSS OF PROPERTY OR OTHER DAMAGE OR LOSSES OWING TO THE FAILURE OF SILENT KNIGHT PRODUCTS BEYOND THE COST OF REPAIR OR REPLACEMENT OF ANY DEFECTIVE PRODUCTS.

SILENT KNIGHT MAKES NO WARRANTY OF FITNESS OR MERCHANTABILITY AND NO OTHER WARRANTY, ORAL OR WRITTEN, EXPRESS OR IMPLIED, BEYOND THE 18 MONTH WARRANTY EXPRESSLY SPECIFIED HEREIN.



7550 Meridian Circle
Maple Grove, MN 55369-4927
763-493-6455
1-800-328-0103
Fax: 763-493-6475

© 1999 Silent Knight
Part Number 15110B 12/99